

**Solutions for Fluid Technology**



油箱  
铝制

**OIL TANKS**  
ALUMINIUM

## 铝制油箱 AB 3,5

## ALUMINIUM OIL TANKS AB 3,5

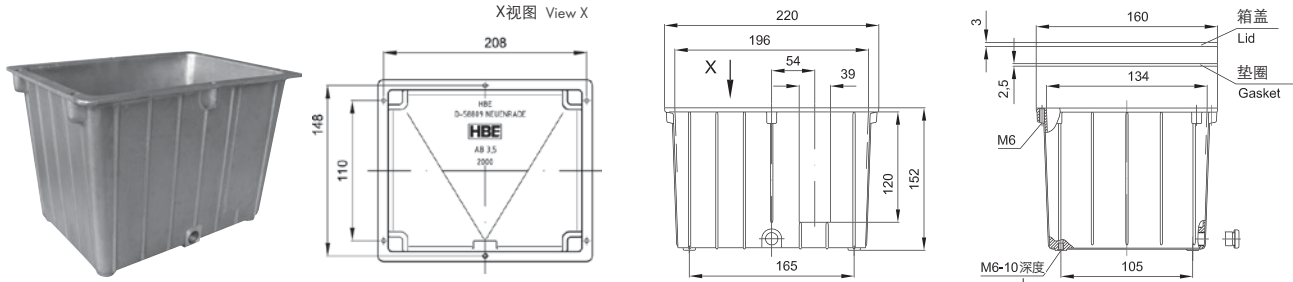

部件号 PART NO.	订货号 ORDERING CODE	描述	DESCRIPTION
2000	AB 3,5	油箱的有效容积大约3升 重量 1 千克, 可堆叠	Tank Effective capacity approx. 3 L weight 1 kg · stackable
2200	SD 3,5	钢制箱盖经机加工安装在油箱上, 也可以未经加工 或 根据客户提供的图纸进行全部加工	Steel lid machined for mounting on the tank, otherwise unmachined, unprimed or completely machined acc. to customer's drawing
2230	D 3,5A	垫圈 (纸基)	Gasket (paperboard)
2238	D 3,5GK	垫圈 (软木橡皮)	Gasket (rubber cork)
2260	AS G 1/4"	放油塞	Drain plug
2261	G 1/4"	铜制油塞垫 (14x18x1,5)*	CU-Gasket (14x18x1,5)*
2371	SE 1	过滤注油塞 (金属制)*	Filler (metal)*
2340	ÖS 76	油标*	Oil gauge*

## 铝制油箱 AB 6,5

## ALUMINIUM OIL TANKS AB 6,5

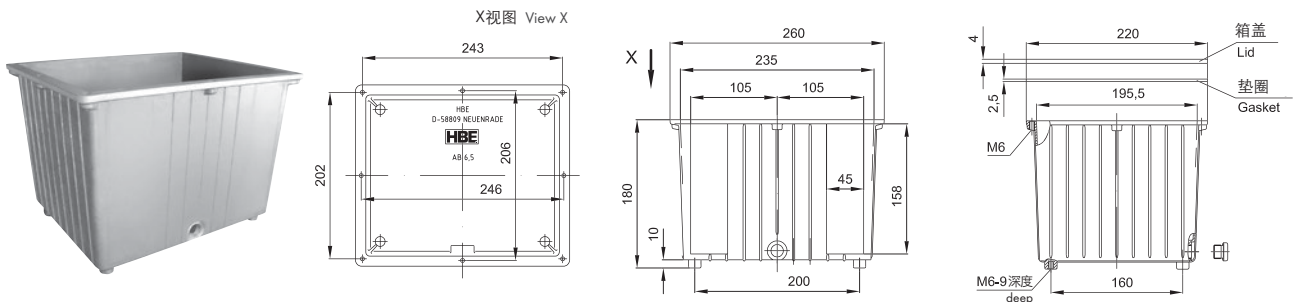

部件号 PART NO.	订货号 ORDERING CODE	描述	DESCRIPTION
2005	AB 6,5	油箱的有效容积大约6升 重量 1,45 千克, 可堆叠	Tank Effective capacity approx. 6 L weight 1,45 kg · stackable
2205	SD 6,5	钢制箱盖经机加工安装在油箱上, 也可以未经加工 或 根据客户提供的图纸进行全部加工	Steel lid machined for mounting on the tank, otherwise unmachined, unprimed or completely machined acc. to customer's drawing
2239	D 6,5A	垫圈 (纸基)	Gasket (paperboard)
2246	D 6,5GK	垫圈 (软木橡皮)	Gasket (rubber cork)
2262	AS G 3/8"	放油塞	Drain plug
2267	G 3/8"	铜制油塞垫 (16x22x2)	CU-Gasket (16x22x2)
2371	SE 1	过滤注油塞 (金属制)*	Filler (metal)*
2340	ÖS 76	油标*	Oil gauge*
2350	ÖS 127	油标*	Oil gauge*

铝制油箱 AB 12 NR

ALUMINIUM OIL TANKS AB 12 NR

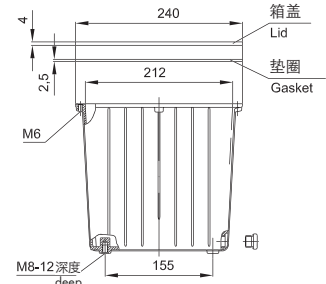
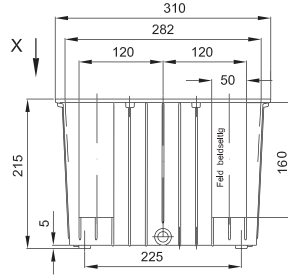
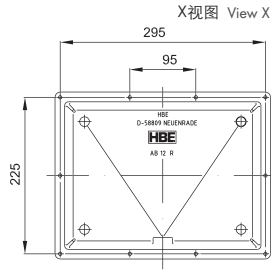

部件号 PART NO.	订货号 ORDERING CODE	描述	DESCRIPTION
2007	AB 12 NR	油箱的有效容积大约11升 重量 3 千克, 可堆叠	Tank Effective capacity approx. 11 L weight 3 kg · stackable
2216	SD 12 NR	钢制箱盖经机加工安装在油箱上, 也可以未经加工 或 根据客户提供的图纸进行全部加工	Steel lid machined for mounting on the tank, otherwise unmachined, unprimed or completely machined acc. to customer's drawing
2236	D 12A NR	垫圈 (纸基)	Gasket (paperboard)
2240	D 12GK NR	垫圈 (软木橡皮)	Gasket (rubber cork)
2262	AS G <sup>3/8</sup> "	放油塞	Drain plug
2267	G <sup>3/8</sup> "	铜制油塞垫 (16x22x2)	CU-Gasket (16x22x2)
2371	SE 1	过滤注油塞 (金属制)*	Filler (metal)*
2340	ÖS 76	油标*	Oil gauge*
2350	ÖS 127	油标*	Oil gauge*

铝制油箱 AB 20

ALUMINIUM OIL TANKS AB 20

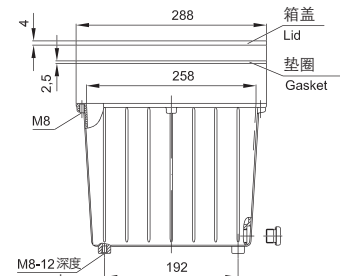
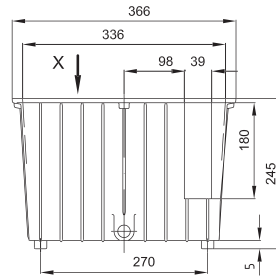
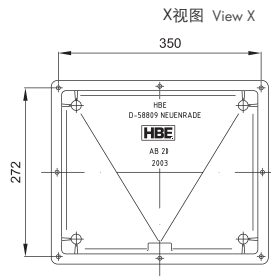

部件号 PART NO.	订货号 ORDERING CODE	描述	DESCRIPTION
2003	AB 20	油箱的有效容积大约17升 重量 4,4 千克, 可堆叠	Tank Effective capacity approx. 17 L weight 4,4 kg · stackable
2203	SD 20	钢制箱盖经机加工安装在油箱上, 也可以未经加工 或 根据客户提供的图纸进行全部加工	Steel lid machined for mounting on the tank, otherwise unmachined, unprimed or completely machined acc. to customer's drawing
2233	D 20 A	垫圈 (纸基)	Gasket (paperboard)
2245	D 20 GK	垫圈 (软木橡皮)	Gasket (rubber cork)
2263	AS G <sup>1/2</sup> "	放油塞	Drain plug
2268	G <sup>1/2</sup> "	铜制油塞垫 (21x26x1,5)	CU-Gasket (21x26x1,5)
2371	SE 1	过滤注油塞 (金属制)*	Filler (metal)*
2340	ÖS 76	油标*	Oil gauge*
2350	ÖS 127	油标*	Oil gauge*

\*其他附件: 请查阅我们的产品样本

\*Accessories: please see our catalogue

## 铝制油箱 AB 30 NR

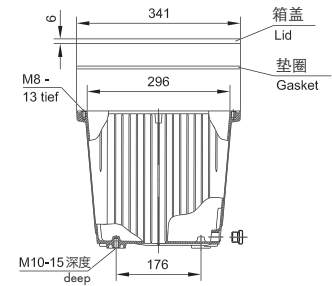
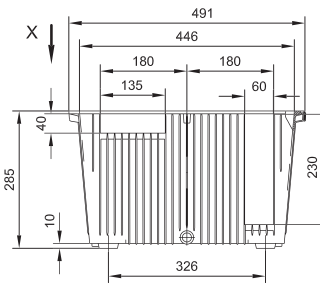
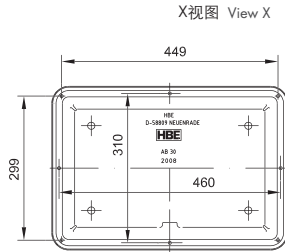

部件号 PART NO.	订货号 ORDERING CODE	描述	DESCRIPTION
2009	AB 30 NR	油箱的有效容积大约26升 重量 5,5 千克, 可堆叠	Tank Effective capacity approx. 26 L weight 5,5 kg · stackable
2204	SD 30	钢制箱盖经机加工安装在油箱上, 也可以未经加工 或 根据客户提供的图纸进行全部加工	Steel lid machined for mounting on the tank, otherwise unmachined, unprimed or completely machined acc. to customer's drawing
2210	AD 30	箱盖经机加工安装在油箱上, 也可以未经加工 或 根据客户提供的图纸进行全部加工	Aluminium lid machined for mounting on the tank, otherwise unmachined, unprimed or completely machined acc. to customer's drawing
2234	D 30 NBR	垫圈 $\varnothing$ 6毫米 NBR	Gasket $\varnothing$ 6 mm NBR
2263	AS G 1/2"	放油塞	Drain plug
2268	G 1/2"	铜制油塞垫 (21 x 26 x 1,5)	CU-Gasket (21 x 26 x 1,5)
2300	F 30	用于AB30的铝制支脚(1套 = 4件)	Aluminium feet for AB 30 (Set=4 pcs.)
2372	SE 2	过滤注油塞(金属制)*	Filler (metal)*
2340	ÖS 76	油标*	Oil gauge*
2350	ÖS 127	油标*	Oil gauge*

## 铝制油箱 AB 44

## ALUMINIUM OIL TANKS AB 44

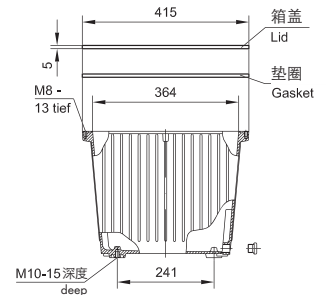
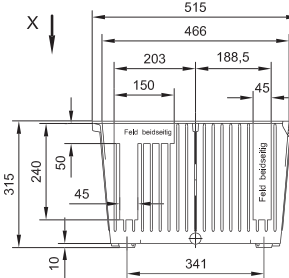
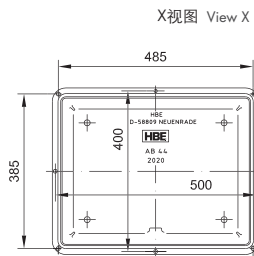

部件号 PART NO.	订货号 ORDERING CODE	描述	DESCRIPTION
2020-1	AB 44	油箱的有效容积大约40升 重量 7 千克, 可堆叠	Tank Effective capacity approx. 40 L weight 7 kg · stackable
2221	SD 44	钢制箱盖经机加工安装在油箱上, 也可以未经加工 或 根据客户提供的图纸进行全部加工	Steel lid machined for mounting on the tank, otherwise unmachined, unprimed or completely machined acc. to customer's drawing
2241	D 44 NBR	垫圈 $\varnothing$ 6毫米 NBR	Gasket $\varnothing$ 6 mm NBR
2263	AS G 1/2"	放油塞	Drain plug
2268	G 1/2"	铜制油塞垫 (21 x 26 x 2,5)	CU-Gasket (21 x 26 x 2,5)
2300	F 44	用于AB44的铝制支脚(1套 = 4件)	Aluminium feet for AB 44 (Set=4 pcs.)
2372	SE 2	过滤注油塞(金属制)*	Filler (metal)*
2340	ÖS 76	油标*	Oil gauge*
2350	ÖS 127	油标*	Oil gauge*
2352	ÖS 176	油标*	Oil gauge*
2384	LR 150	脚轮150毫米*	Castors 150 mm*

\*其他附件: 请查阅我们的产品样本

\*Accessories: please see our catalogue

铝制油箱 AB 70

ALUMINIUM OIL TANKS AB 70

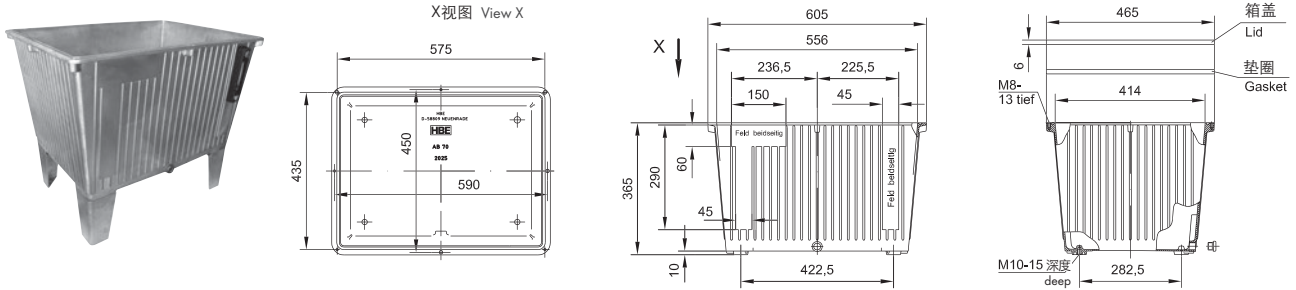

部件号 PART NO.	订货号 ORDERING CODE	描述	DESCRIPTION
<b>2025</b>	AB 70	油箱的有效容积大约63升 重量 12 千克, 可堆叠	<b>Tank</b> Effective capacity approx. 63 L weight 12 kg · stackable
<b>2225</b>	SD 70	钢制箱盖经机加工安装在油箱上, 也可以未经加工 或 根据客户提供的图纸进行全部加工	<b>Steel lid</b> machined for mounting on the tank, otherwise unmachined, unprimed or completely machined acc. to customer's drawing
<b>2242</b>	D 70 NBR	垫圈 $\varnothing$ 6毫米 NBR 肖氏硬度70°	<b>Gasket</b> $\varnothing$ 6 mm NBR 70° Shore
<b>2263</b>	AS G 1/2"	放油塞	<b>Drain plug</b>
<b>2268</b>	G 1/2"	铜制油塞垫 (21 x 26 x 2,5)	<b>CU-Gasket</b> (21 x 26 x 2,5)
<b>2300</b>	F 70	用于AB70的铝制支脚(1套 = 4件)	<b>Aluminium feet for AB 70</b> (Set=4 pcs.)
<b>2372</b>	SE 2	过滤注油塞(金属制)*	<b>Filler (metal)*</b>
<b>2340</b>	ÖS 76	油标*	<b>Oil gauge*</b>
<b>2350</b>	ÖS 127	油标*	<b>Oil gauge*</b>
<b>2352</b>	ÖS 176	油标*	<b>Oil gauge*</b>
<b>2384</b>	LR 150	脚轮150毫米*	<b>Castors</b> 150 mm*

\*其他附件: 请查阅我们的产品样本

\*Accessories: please see our catalogue

AB 70 可以堆叠  
AB 70 STACKABLE



油箱AB 44 带加工箱盖  
可根据客户提供的图纸  
AB 44 WITH LID MACHINING  
ACC. TO CUSTOMER'S DRAWING

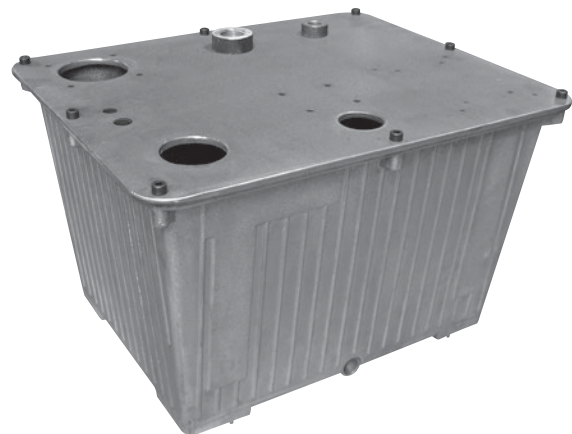

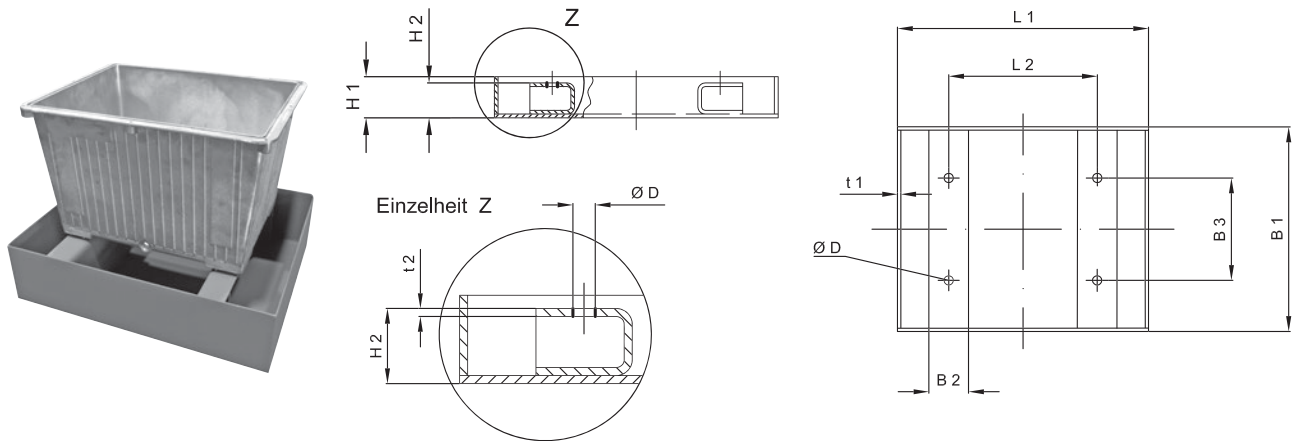

部件号 PART NO.	型号 TYPE	用于 FOR	容积 VOLUME	尺寸 毫米 mm DIMENSIONS mm									
				L <sub>1</sub>	L <sub>2</sub>	B <sub>1</sub>	B <sub>2</sub>	B <sub>3</sub>	H <sub>1</sub>	H <sub>2</sub>	t <sub>1</sub>	t <sub>2</sub>	D
1080	ÖW 12 ST	AB 12 NR	11,8 L	380	225,0	310	60	155	110	100	3	3	9,5
1081	ÖW 20 ST	AB 20	20 L	570	270,0	350	60	192	110	100	3	3	9,5
1082	ÖW 30 ST	AB 30 NR	33 L	550	326,0	400	60	176	160	150	3	5	12,0
1083	ÖW 44 ST	AB 44	45 L	600	341,0	500	60	241	160	150	3	5	12,0
1084	ÖW 70 ST	AB 70	63,5 L	730	422,5	580	60	282,5	160	150	3	5	12,0

**ÖW 12 – ÖW 70**

用于铝油箱AB 12 – AB 70的集油槽

材质 ST 37 (或 V2A / V4A)

ST 37经喷砂和打磨处理

耐油 (矿物有 HL / HLP)

焊接工艺符合 § 19.1 (WHG)

**ÖW 12 – ÖW 70**

Oil sumps for aluminium tanks AB 12 – AB 70

Material ST 37 (alt. V2A/V4A)

ST 37 sandblasted and grounded regarding oil resistance (mineral oil HL/HLP)

Approved welding shop acc. to § 19.1 (WHG)

\*其他附件: 请查阅我们的产品样本

\*Accessories: please see our catalogue

**技术参数  
铝油箱****TECHNICAL DATA  
ALUMINIUM OIL TANKS**

油箱尺寸 SIZE OF TANK	有效容积 EFFECTIVE VOLUME	比冷却能力 SPECIFIC COOLING CAPACITY P/Δt [W/K]	冷却能力* COOLING CAPACITY* P[kW] Δt= 40K	含油箱盖的表 面积 SURFACE WITH TANK LID m <sup>2</sup>	重量 WEIGHT kg
V	V				
NG 3.5	3	4	0.16	0.15	1.4
NG 6.5	6	9	0.36	0.25	1.7
NG 8	6.5	11	0.44	0.3	2.5
NG 12	10	15	0.6	0.35	2.3
NG 13	11	15	0.6	0.4	2.8
NG 20	17	18	0.72	0.5	4.3
NG 30	27	23	0.92	0.75	5
NG 44	40	26	1.04	1	7
NG 70	63	29	1.16	1.3	10

\*取决于周围环境条件

\*Depending on surrounding conditions



## 通用技术信息

- 所有尺寸的铝油箱都可以堆叠, 因此可以显著节省运费和空间
- 铝制的箱体布满沟槽, 坚固而且散热性能好
- 油箱AB 30 - AB 70可以配支脚 或 脚轮
- 油箱AB 3,5 - AB 20 的箱盖和箱体之间配有橡胶软木垫
- 油箱AB 30 - AB 70的箱盖 和 箱体之间配有直径6毫米环形截面的密封圈
- 可以根据客户图纸提供所有尺寸油箱的油箱盖 (如果需要, 包括喷涂)
- 所有尺寸油箱包括标准的油箱附件都有库存

## GENERAL TECHNICAL INFORMATION

- All aluminium tank sizes are stackable, thus low freight cost and space saving storage
- Stable casted body with good heat dissipation by material aluminium and all-round fluting
- AB 30 - AB 70 available with feet or castors alternatively
- Flat gasket made of rubber cork between tank lid and tank for AB 3,5 - AB 20
- Toroidal sealing ring (endless, without contact spot) 6 mm  $\varnothing$  NBR for AB 30 - AB 70
- Tank lid for all sizes according to customer's drawing (coating included, if desired)
- All tank sizes incl. standard accessories ex stock

## 适应性清单 针对矿物油和防火油

## LIST OF RESISTANCE against mineral oils and flame resistant fluids

产品 PRODUCT	材质 MATERIAL	介质 MEDIUM				
		液压油 / 矿物油基 Hydraulic oil / Mineral oil base	HFA	HFB	HFC	HFD, HFD-R, HFD-S, HFD-T
钢制油箱 / Steel tanks	钢 / Steel	●	1	●	●	●
表面喷涂 / Coating	ME III	●	●	●	2	2
垫圈 / Gasket	NBR	●	●	●	●	●
垫圈 / Gasket	EPDM	●	●	●	●	●
油箱 AB / AB-tanks	铝 / Aluminium	●	●	●	●	●
垫圈 / Gasket	纸基 / Paperboard	●	●	●	●	●
垫圈 / Gasket	橡胶软木 / Rubber cork	●	●	●	3	3
油箱盖 / Lid SD	钢 / Steel	●	1	●	●	●
油标 / Oil gauges						
带垫圈 / with gasket	NBR	●	●	●	●	●
带垫圈 / with gasket	FPM	●	●	●	●	●
过滤注油塞 / Filler	ST	●	●	●	●	●
清洗端盖 / Cleaning cover	铝 / Aluminium	●	●	●	●	●
带垫圈 / with gasket	NBR	●	●	●	●	●
带垫圈 / with gasket	FPM	●	●	●	●	●
带垫圈 / with gasket	EPDM	●	●	●	●	●

● = 适用    ● = 不适用    1 = 需要底涂    2 = 如需要涂层, 推荐环氧树脂    3 = 具有防潮性  
 ● = resistant    ● = nonresistant    1 = Priming coat required    2 = If coating required, epoxyd-rosin is to be used    3 = Resistant to moisture by oil

## 液压油 / 主要成分







- HFA** 油包水乳化液, 水含量 > 80%
- HFB** 水包油乳化液, 水含量 > 40%
- HFC** 水乙二醇液  
水含量 > 45%
- HFD** 合成液压油 (无水)
- HFD-R** 磷酸酯液
- HFD-S** 氯代烃溶剂
- HFD-T** HFD-R 和 HFD-S混合液

## HYDRAULIC FLUIDS / MAIN COMPONENTS

- HFA** Oil in water emulsion, water content > 80 %
- HFB** Water in oil emulsion, water content > 40 %
- HFC** Watery Polymersolution (waterglycol)  
water content > 45 %
- HFD** Synthetic fluids (free of water)
- HFD-R** Phosphoric acid ester
- HFD-S** Chlorinated hydrocarbon
- HFD-T** Mixture of HFD-R + HFD-S

HBE 保留任何时间调整技术参数权利

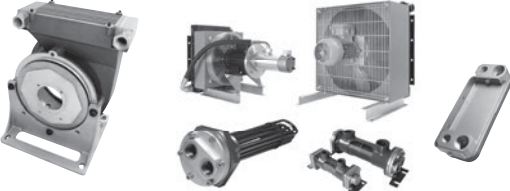
HBE reserves the right to modify technical data at any time.

<p>铝制油箱 Oil tanks made of aluminium</p>	
<p>清洗端盖和附件 液位计和温度计 Cleaning covers and further tank accessories Level- and temperature indicators</p>	
<p>油箱加热器 Tank heaters</p>	
<p>钟罩和附件 Bellhousings and accessories</p>	
<p>带冷却器的钟罩 各类换热器 DOC® 钎焊板式换热器 Bellhousing with oil-cooler Heat exchangers DOC® Brazed plate heat exchanger</p>	
<p>SOFTEX® 弹性和无背隙联轴器 SOFTEX® elastic and no backlash shaft couplings</p>	
<p>STAREX® 齿面联轴器 STAREX® flexible couplings</p>	
<p>内燃机联轴器 Diesel engine couplings</p>	